

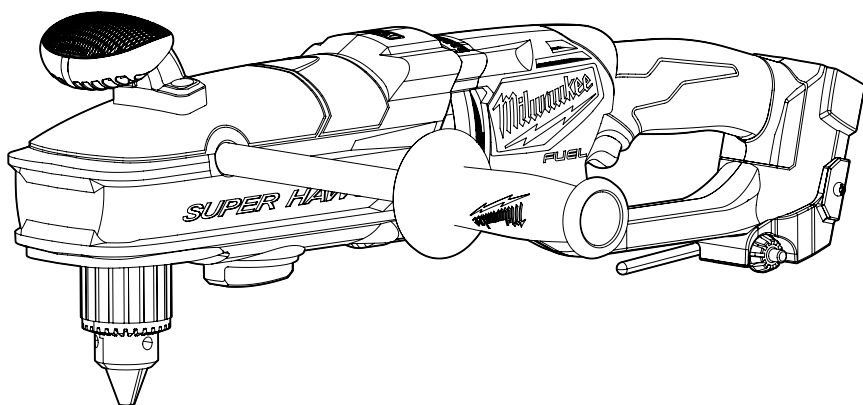

OPERATOR'S MANUAL



Cat. No.
M18FRAD2-0

M18 FUEL™ SUPER HAWG™ RIGHT ANGLE DRILLS

 **WARNING**

To reduce the risk of injury, user must read and understand operator's manual.



GENERAL POWER TOOL SAFETY WARNINGS

WARNING Read all safety warnings, instructions, illustrations and specifications provided with this power tool. Failure to follow all instructions listed below may result in electric shock, fire and/or serious injury. **Save all warnings and instructions for future reference.** The term "power tool" in the warnings refers to your mains-operated (corded) power tool or battery-operated (cordless) power tool.

WORK AREA SAFETY

- **Keep work area clean and well lit.** Cluttered or dark areas invite accidents.
- **Do not operate power tools in explosive atmospheres, such as in the presence of flammable liquids, gases or dust.** Power tools create sparks which may ignite the dust or fumes.
- **Keep children and bystanders away while operating a power tool.** Distractions can cause you to lose control.

ELECTRICAL SAFETY

- **Power tool plugs must match the outlet. Never modify the plug in any way. Do not use any adapter plugs with earthed (grounded) power tools.** Unmodified plugs and matching outlets will reduce risk of electric shock.
- **Avoid body contact with earthed or grounded surfaces, such as pipes, radiators, ranges and refrigerators.** There is an increased risk of electric shock if your body is earthed or grounded.
- **Do not expose power tools to rain or wet conditions.** Water entering a power tool will increase the risk of electric shock.
- **Do not abuse the cord. Never use the cord for carrying, pulling or unplugging the power tool. Keep cord away from heat, oil, sharp edges or moving parts.** Damaged or entangled cords increase the risk of electric shock.
- **When operating a power tool outdoors, use an extension cord suitable for outdoor use.** Use of a cord suitable for outdoor use reduces the risk of electric shock.
- **If operating a power tool in a damp location is unavoidable, use a residual charge device (RCD) protected supply.** Use of a RCD reduces the risk of electric shock.

PERSONAL SAFETY

- **Stay alert, watch what you are doing and use common sense when operating a power tool. Do not use a power tool while you are tired or under the influence of drugs, alcohol or medication.** A moment of inattention while operating power tools may result in serious personal injury.
- **Use personal protective equipment. Always wear eye protection.** Protective equipment such as a dust mask, non-skid safety shoes, hard hat or hearing protection used for appropriate conditions will reduce personal injuries.
- **Prevent unintentional starting. Ensure the switch is in the off-position before connecting to power source and/or battery pack, picking up or carrying the tool.** Carrying power tools with your finger on the switch or energizing power tools that have the switch on invites accidents.
- **Remove any adjusting key or wrench before turning the power tool on.** A wrench or a key left attached to a rotating part of the power tool may result in personal injury.

- **Do not overreach. Keep proper footing and balance at all times.** This enables better control of the power tool in unexpected situations.
- **Dress properly. Do not wear loose clothing or jewelry. Keep your hair and clothing away from moving parts.** Loose clothes, jewelry or long hair can be caught in moving parts.
- **If devices are provided for the connection of dust extraction and collection facilities, ensure these are connected and properly used.** Use of dust collection can reduce dust-related hazards.
- **Do not let familiarity gained from frequent use of tools allow you to become complacent and ignore tool safety principles.** A careless action can cause severe injury within a fraction of a second.

POWER TOOL USE AND CARE

- **Do not force the power tool. Use the correct power tool for your application.** The correct power tool will do the job better and safer at the rate for which it was designed.
 - **Do not use the power tool if the switch does not turn it on and off.** Any power tool that cannot be controlled with the switch is dangerous and must be repaired.
 - **Disconnect the plug from the power source and/or remove the battery pack, if detachable, from the power tool before making any adjustments, changing accessories, or storing power tools.** Such preventive safety measures reduce the risk of starting the power tool accidentally.
 - **Store idle power tools out of the reach of children and do not allow persons unfamiliar with the power tool or these instructions to operate the power tool.** Power tools are dangerous in the hands of untrained users.
 - **Maintain power tools and accessories. Check for misalignment or binding of moving parts, breakage of parts and any other condition that may affect the power tool's operation. If damaged, have the power tool repaired before use.** Many accidents are caused by poorly maintained power tools.
 - **Keep cutting tools sharp and clean.** Properly maintained cutting tools with sharp cutting edges are less likely to bind and are easier to control.
 - **Use the power tool, accessories and tool bits etc. in accordance with these instructions, taking into account the working conditions and the work to be performed.** Use of the power tool for operations different from those intended could result in a hazardous situation.
 - **Keep handles and grasping surfaces dry, clean and free from oil and grease.** Slippery handles and grasping surfaces do not allow for safe handling and control of the tool in unexpected situations.
- ### BATTERY TOOL USE AND CARE
- **Recharge only with the charger specified by the manufacturer.** A charger that is suitable for one type of battery pack may create a risk of fire when used with another battery pack.
 - **Use power tools only with specifically designated battery packs.** Use of any other battery packs may create a risk of injury and fire.
 - **When battery pack is not in use, keep it away from other metal objects, like paper clips, coins, keys, nails, screws or other small metal objects, that can make a connection from one terminal to another.** Shorting the battery terminals together may cause burns or a fire.

•Under abusive conditions, liquid may be ejected from the battery; avoid contact. If contact accidentally occurs, flush with water. If liquid contacts eyes, additionally seek medical help. Liquid ejected from the battery may cause irritation or burns.

•Do not use a battery pack or tool that is damaged or modified. Damaged or modified batteries may exhibit unpredictable behavior resulting in fire, explosion or risk of injury.

•Do not expose a battery pack or tool to fire or excessive temperature. Exposure to fire or temperature above 265°F (130°C) may cause explosion.

•Follow all charging instructions and do not charge the battery pack or tool outside the temperature range specified in the instructions. Charging improperly or at temperatures outside the specified range may damage the battery and increase the risk of fire.

SERVICE

•Have your power tool serviced by a qualified repair person using only identical replacement parts. This will ensure that the safety of the power tool is maintained.

•Never service damaged battery packs. Service of battery packs should only be performed by the manufacturer or authorized service providers.

SPECIFIC SAFETY RULES FOR SUPER HAWG™

•Use auxiliary handle(s), if supplied with the tool. Loss of control can cause personal injury.

•Hold power tool by insulated gripping surfaces, when performing an operation where the cutting accessory may contact hidden wiring. Cutting accessory contacting a "live" wire may make exposed metal parts of the power tool "live" and could give the operator an electric shock.

AWARNING To reduce the risk of injury in applications that produce a considerable amount of dust, use an appropriate dust extraction solution in accordance with the solution's operating instructions.

•Always use common sense and be cautious when using tools. It is not possible to anticipate every situation that could result in a dangerous outcome. Do not use this tool if you do not understand these operating instructions or you feel the work is beyond your capability; contact MILWAUKEE® Tool or a trained professional for additional information or training.

•Maintain labels and nameplates. These carry important information. If unreadable or missing, contact a MILWAUKEE® service facility for a replacement.



AWARNING Some dust created by power sanding, sawing, grinding, drilling, and other construction activities contains chemicals known to cause cancer, birth defects or other reproductive harm. Some examples of these chemicals are:

- lead from lead-based paint
 - crystalline silica from bricks and cement and other masonry products, and
 - arsenic and chromium from chemically-treated timber.
- Your risk from these exposures varies, depending on how often you do this type of work. To reduce your exposure to these chemicals: work in a well ventilated area, and work with approved safety equipment, such as those dust masks that are specially designed to filter out microscopic particles.

ADDITIONAL BATTERY SAFETY RULES

AWARNING To reduce the risk of fire, personal injury, and product damage due to a short circuit, never immerse your tool, battery pack or charger in fluid or allow a fluid to flow inside them. Corrosive or conductive fluids, such as seawater, certain industrial chemicals, and bleach or bleach-containing products, etc., can cause a short circuit.

SYMBOLGY

-  Volts
-  Direct Current
- n_r XXXX min⁻¹ No Load Revolutions per Minute (RPM)
-  Regulatory Compliance mark (RCM). This product meets applicable regulatory requirements.

SPECIFICATIONS

Cat. No.	M18FRAD2-0
Volts.....	18V DC
Battery Type	M18™
Charger Type	M18™
No Load RPM	High 0-1550, Low 0-500
Recommended Ambient Operating Temperature.....	-18°C to 51°C

Capacities:

Steel	
Twist Bit	High 8 mm, Low 13 mm
Wood	
Auger Bit	High/Low 38 mm
Ship Auger Bit	High/Low 38 mm
Selffeed Bit	High 65 mm, Low 159 mm
Hole Saw	High 102mm, Low 159 mm

FUNCTIONAL DESCRIPTION

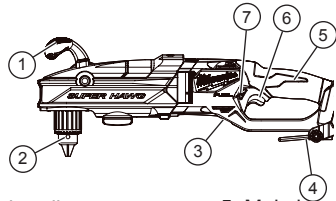

- | | |
|----------------------|-------------------|
| 1. Top handle | 5. Main handle |
| 2. 1/2" Keyed chuck | 6. Trigger |
| 3. LED | 7. Control switch |
| 4. Chuck key storage | |

ASSEMBLY

AWARNING Recharge only with the charger specified for the battery. For specific charging instructions, read the operator's manual supplied with your charger and battery.

Removing/Inserting the Battery

To remove the battery, push in the release buttons and pull the battery pack away from the tool.

AWARNING Always remove battery pack before changing or removing accessories.

To insert the battery, slide the pack into the body of the tool. Make sure it latches securely into place.

AWARNING Only use accessories specifically recommended for this tool. Others may be hazardous.

Bit Selection

- Use sharp bits. Sharp bits are less likely to bind when drilling.
- Use the proper bit for the job. There are many types of bits designed for specific purposes. Check the information on the bit's packaging for proper usage.
- Do not use bits larger than the rated capacity of the drill. Gear damage or motor overload may result (see "Specifications").

Installing Bits

Always remove the battery before inserting or removing bits. Select the proper style and size bit for the application.

Installing Bits into Keyed Chucks

1. Remove the battery pack.
 2. Open the chuck jaws wide enough to insert the bit. Be sure the bit shank and chuck jaws are clean. Dirt particles may prevent the bit from lining up properly.
 3. Insert the bit into the chuck. Centre the bit in the chuck jaws and lift it about 1/16" off of the bottom. Tighten the chuck jaws by hand to align the bit.
 4. Place the chuck key in each of the three holes in the chuck, turning it clockwise to tighten the chuck securely.
- NOTE:** Never use a wrench or means other than a chuck key to tighten or loosen the chuck.
5. To remove the bit, insert the chuck key into one of the holes in the chuck and turn it counterclockwise.

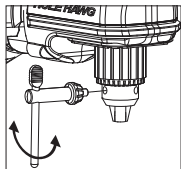

Installing Bits into 7/16" Hex QUIK-LOK™ Chuck

1. Remove the battery pack.
2. To attach an accessory, press the shank into the hex drive QUIK-LOK™ chuck.
3. To remove the accessory, pull out the QUIK-LOK™ chuck ring and remove the accessory. Release the ring.

Side Handle

The side handle can be installed on either side of the tool. To install the side handle, thread it into the socket on the desired side of the tool and tighten it securely.

OPERATION

⚠WARNING To reduce the risk of injury, always wear proper eye protection marked to comply with AS:NZS 1336:2014.

When working in dusty situations, wear appropriate respiratory protection or use an appropriate dust extraction solution.

Bit binding

If the bit binds, the drill will suddenly react in the opposite direction of the rotation of the bit. Reduce the chances of a sudden reaction by following the instructions listed below. Prepare for a sudden reaction by holding or bracing securely.

To reduce the chance of bit binding:

- Use sharp bits. Sharp bits are less likely to bind when drilling.
- Use the proper bit for the job. There are many types of bits designed for specific purposes.

- Keep selffeed bits aligned with the work surface so bits go in straight (see "Drilling").
- Avoid drilling warped, wet, knotty, and/or pitchy material if possible.
- Avoid drilling in material that you suspect contains hidden nails or other things that may cause the bit to bind.

The direction of reaction is always opposite of the direction of bit rotation. Reaction is even more likely to occur when enlarging already existing holes and at the point when the bit breaks through the other side of the material.

If the bit does bind:

1. Release the trigger immediately.
2. Reverse the motor.
3. Remove the bit from the work and start again.
4. Do not pull the trigger on and off to attempt to start a stalled bit. This will damage the drill.

Bracing for forward rotation

When drilling in forward, the bit will rotate in a clockwise direction. If the bit binds in the hole, the bit will come to a sudden stop and drill will suddenly react in a counterclockwise direction.

The following figure shows an example of properly bracing the tool for forward rotation.

- A. Forward (clockwise) rotation
 - B. Reaction
 - C. Brace drill with motor housing here
- If the bit binds, the motor housing braced against the stud will hold the drill in position.

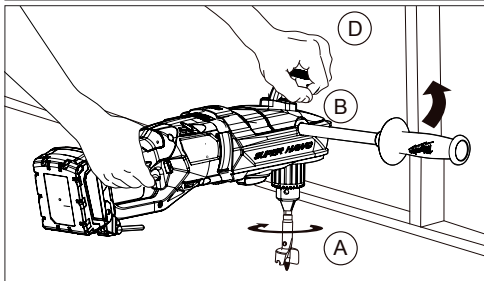
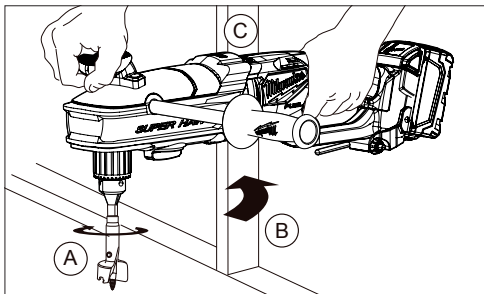

Bracing for reverse rotation

When drilling in reverse, the bit will rotate in a counterclockwise direction. If the bit binds in the hole, the bit will come to a sudden stop and the drill will suddenly react in a clockwise direction.

The following figure shows an example of properly bracing the tool for reverse rotation.

- A. Reverse (counterclockwise) rotation
- B. Reaction
- C. Brace drill with motor housing here

If the bit binds, the motor housing braced against the stud will hold the drill in position.

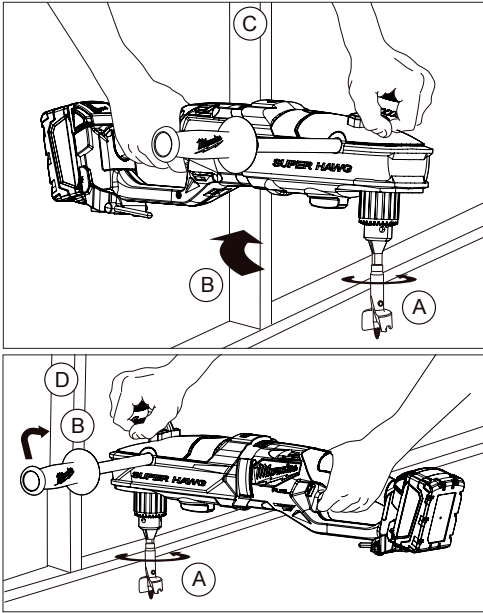

Shifting Speeds

Use the shift knob to select High (H) or Low (L) speed. High speed (1,550 RPM) is the low torque setting. Low speed (500 RPM) is the high torque setting. See the "Specifications" section for bit capacity limits under high and low speeds.

Always turn off the switch and shift speeds while the tool is stopped. Never shift the drill while it is moving or when it is under load.

Using Control Switch

The control switch may be set to three positions: forward, reverse and lock. Due to a lockout mechanism, the control switch can only be adjusted when the trigger is not pulled. Always allow the motor to come to a complete stop before using the control switch.

For **Forward** (clockwise) rotation, push the control switch from the left side of the tool. **Check the direction of rotation before use.**

For **Reverse** (counterclockwise) rotation, push the control switch from the right side of the tool. **Check direction of rotation before use.**

To **Lock** the trigger, push the control switch to the centre position. The trigger will not work while the control switch is in the centre locked position. Always lock the trigger or remove the battery pack before performing maintenance, changing accessories, storing the tool and any time the tool is not in use.

Starting, Stopping and Controlling Speed

These tools may be operated at any speed from 0 to full speed.

1. To **start** the tool, pull the trigger.

NOTE: An LED is turned on when the trigger is pulled.

2. To **vary** the driving speed, increase or decrease pressure on the trigger. The further the trigger is pulled, the greater the speed.

3. To **stop** the tool, release the trigger.

Drilling

1. Before drilling, be sure the workpiece is clamped securely. A poorly secured piece of material may result in personal injury or inaccurate drilling. Use backing material to prevent damage to the workpiece during breakthrough. When drilling in light gauge metal or wood, use a wooden block to back up the material to prevent damage to the workpiece.
2. When starting a hole, place the drill bit on the work surface and apply firm pressure. To start a selffeed bit, run the threaded feed screw into the work by flicking the trigger switch, permitting the bit to coast until the teeth contact the work surface. Align the bit properly before proceeding. This will reduce cocking and jamming when starting. When drilling in metal, mark the centre of the hole to be drilled with a centre punch to give the bit a start and to prevent it from "walking." Lubricate the drill bit with cutting oil when drilling iron or steel. Use a coolant when drilling nonferrous metals such as copper, brass or aluminum.
3. Always apply pressure in line with the bit. Use enough pressure to keep the drill biting, but do not push hard enough to cause the bit to bind. When using twist drill bits, pull the bit out frequently to clear chips from the flutes. When using selffeed bits, if the clutch slips, pull the bit up very slightly and then push it toward the workpiece. Repeat this several times.
4. Reduce pressure and ease the bit through the last part of the hole. While the tool is still running, pull the bit out of the hole to prevent jamming. When using selffeed bits, decrease the drilling pressure when the feed screw point breaks through the workpiece. Proceed with steady, even pressure.

APPLICATIONS

WARNING To reduce the risk of electric shock, check work area for hidden pipes and wires before drilling or driving screws.

Drilling in Wood, Composite Materials and Plastic

When drilling in wood, composition materials and plastic, select the drill operating mode. Start the drill slowly, gradually increasing speed as you drill. Use low speeds for plastics with a low melting point.

Drilling in Metal

When drilling in metal, select the drill operating mode. Use high speed steel twist drills or hole saws. Use a centre punch to start the hole. Lubricate drill bits with cutting oil when drilling in iron or steel. Use a coolant when drilling in nonferrous metals such as copper, brass or aluminum. Back the material to prevent binding and distortion on breakthrough.

Overloading

Continuous overloading may cause permanent damage to tool or battery pack.

MAINTENANCE

▲WARNING To reduce the risk of injury, always unplug the charger and remove the battery pack from the charger or tool before performing any maintenance. Never disassemble the tool, battery pack or charger. Contact a MILWAUKEE® service facility for ALL repairs.

Maintaining Tool

Keep your tool, battery pack and charger in good repair by adopting a regular maintenance program. Inspect your tool for issues such as undue noise, misalignment or binding of moving parts, breakage of parts, or any other condition that may affect the tool operation. Return the tool, battery pack, and charger to a MILWAUKEE® service facility for repair. After six months to one year, depending on use, return the tool, battery pack and charger to a MILWAUKEE® service facility for inspection.

If the tool does not start or operate at full power with a fully charged battery pack, clean the contacts on the battery pack. If the tool still does not work properly, return the tool, charger and battery pack, to a MILWAUKEE® service facility for repairs.

▲WARNING To reduce the risk of personal injury and damage, never immerse your tool, battery pack or charger in liquid or allow a liquid to flow inside them.

Cleaning

Clean dust and debris from vents. Keep handles clean, dry and free of oil or grease. Use only mild soap and a damp cloth to clean, since certain cleaning agents and solvents are harmful to plastics and other insulated parts. Some of these include gasoline, turpentine, lacquer thinner, paint thinner, chlorinated cleaning solvents, ammonia and household detergents containing ammonia. Never use flammable or combustible solvents around tools.

Repairs

For repairs, return the tool, battery pack and charger to the nearest service centre.

ACCESSORIES

▲WARNING Use only recommended accessories. Others may be hazardous.

For a complete listing of accessories, go online to www.milwaukeeetools.com.au/ [www.milwaukeeetools.co.nz.](http://www.milwaukeeetools.co.nz/) or contact a distributor.

WARRANTY - AUSTRALIA and NEW ZEALAND

Please refer to Australian and New Zealand warranty supplied with tool. This warranty applies only to product sold in Australia and New Zealand.

SERVICE - AUSTRALIA and NEW ZEALAND

MILWAUKEE® prides itself in producing a premium quality product that is Nothing But Heavy Duty®. Your satisfaction with our products is very important to us! If you encounter any problems with the operation of this tool, please contact your authorised **MILWAUKEE®** dealer.

For a list of **MILWAUKEE®** dealers, guarantee or service agents please contact **MILWAUKEE®** Customer Service or visit our website.

(Australia Toll Free Telephone Number 1300 645 928)

(New Zealand Toll Free Telephone Number 0800 645 928)

or visit www.milwaukeetools.com.au / www.milwaukeetools.co.nz.

Milwaukee Electric Tool Corporation

13135 West Lisbon Road, Brookfield, Wisconsin U.S.A. 53005

Milwaukee Tool (Australia)

21 Kelletts Road, Rowville, VIC 3178
Melbourne, Australia

Milwaukee Tool (New Zealand)

274 Church Street, Penrose,
Auckland, 1061, New Zealand

Designed by Milwaukee Electric Tool Corp.

Professionally Made in China for Milwaukee Tool (Australia) / Milwaukee Tool (New Zealand)

Printed in China